



SNC • LAVALIN

ATKINS

Member of the SNC-Lavalin Group

Aspect 2019: What Building a Model
Taught Me About the Real Railway
Aaron Sawyer

Operational Railway Model

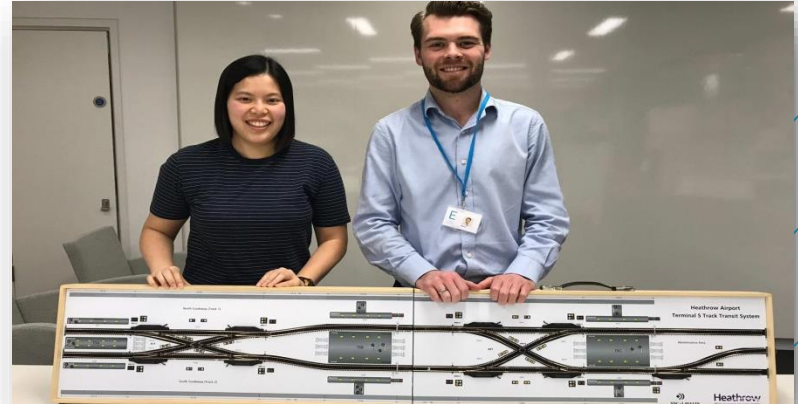
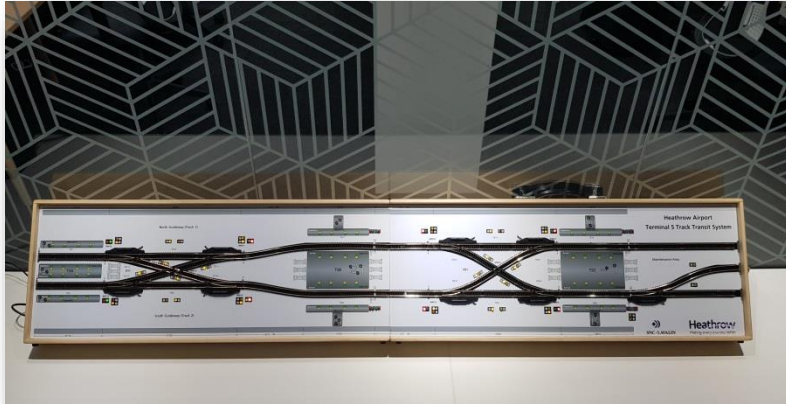

What Building a Model Taught Me About the Real Railway

Heathrow

Heathrow Express



T5 A

T5 B

T5 C



Track Transit System



Overcrowding



What next then ?



Shuttle

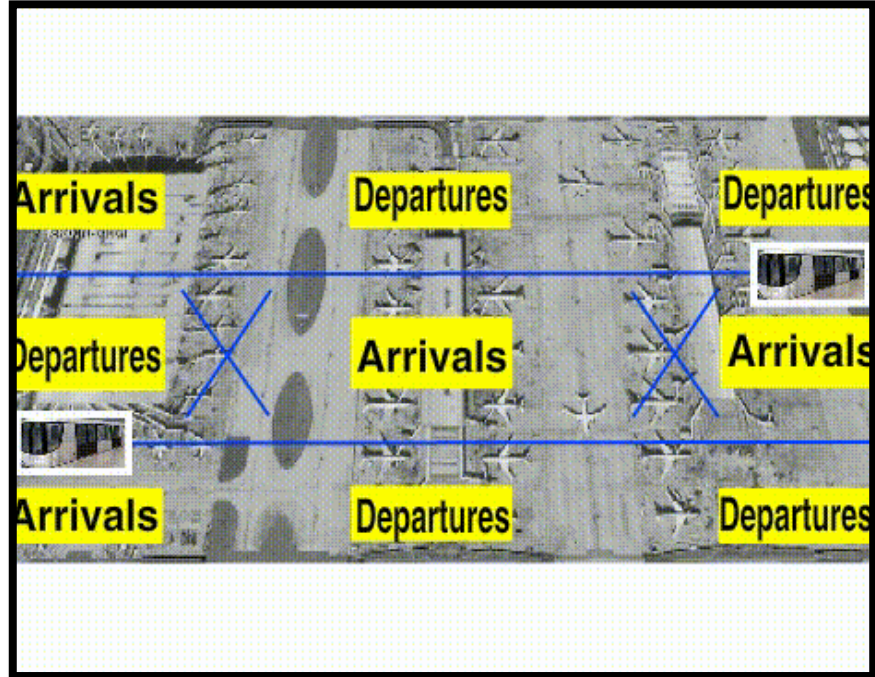

Loop

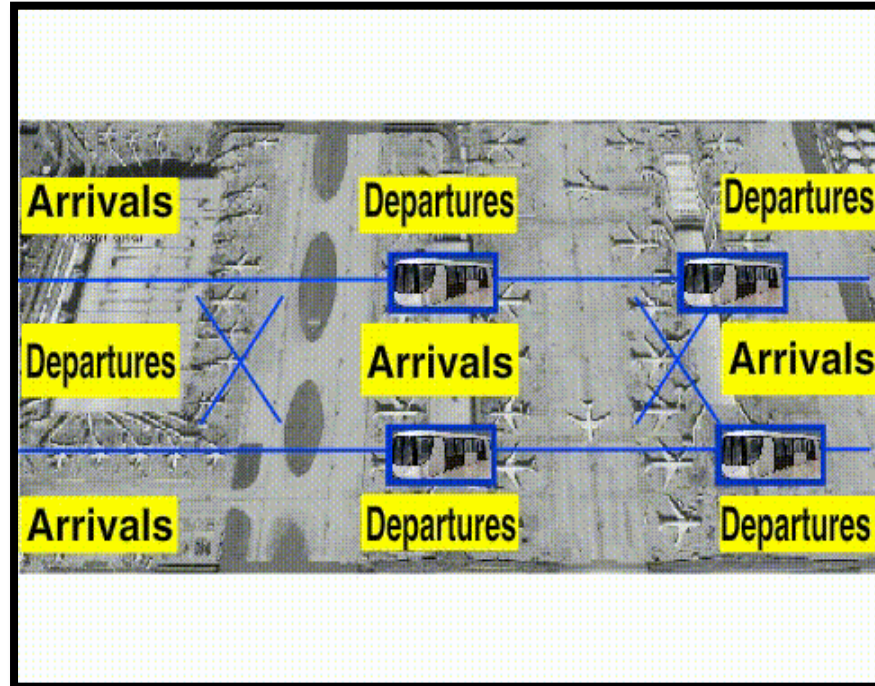

What did I do ?



My Challenge

Create an Operational Railway Model

1. Demonstrate
2. Train Operators
3. Engage

The Design



N-Scale Track Layout

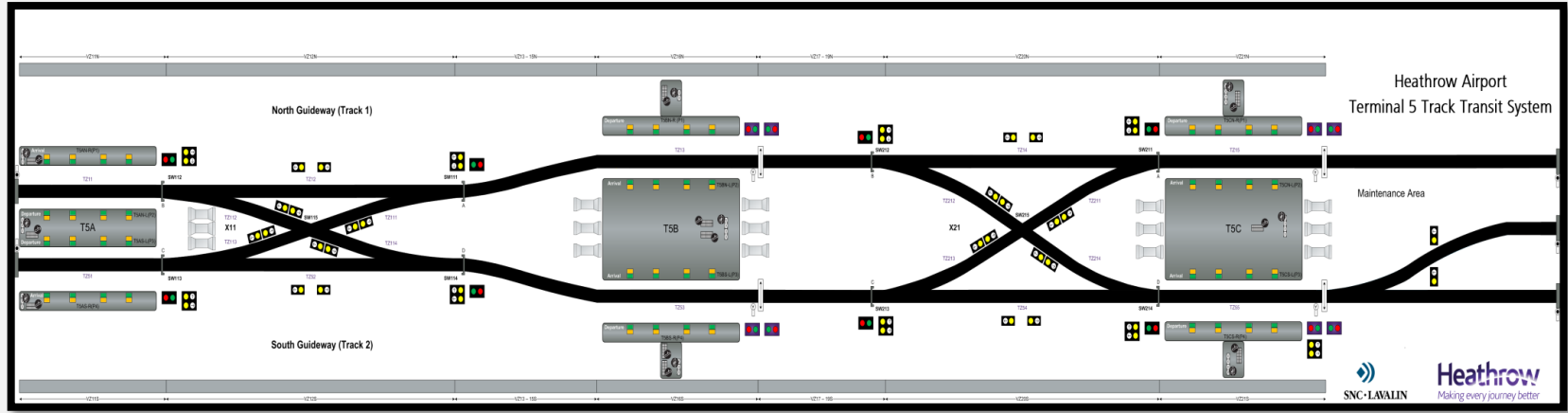

2 m

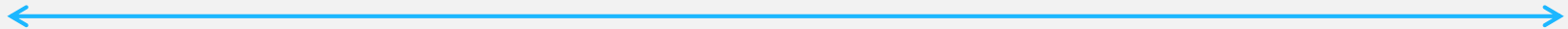





Control System Architecture

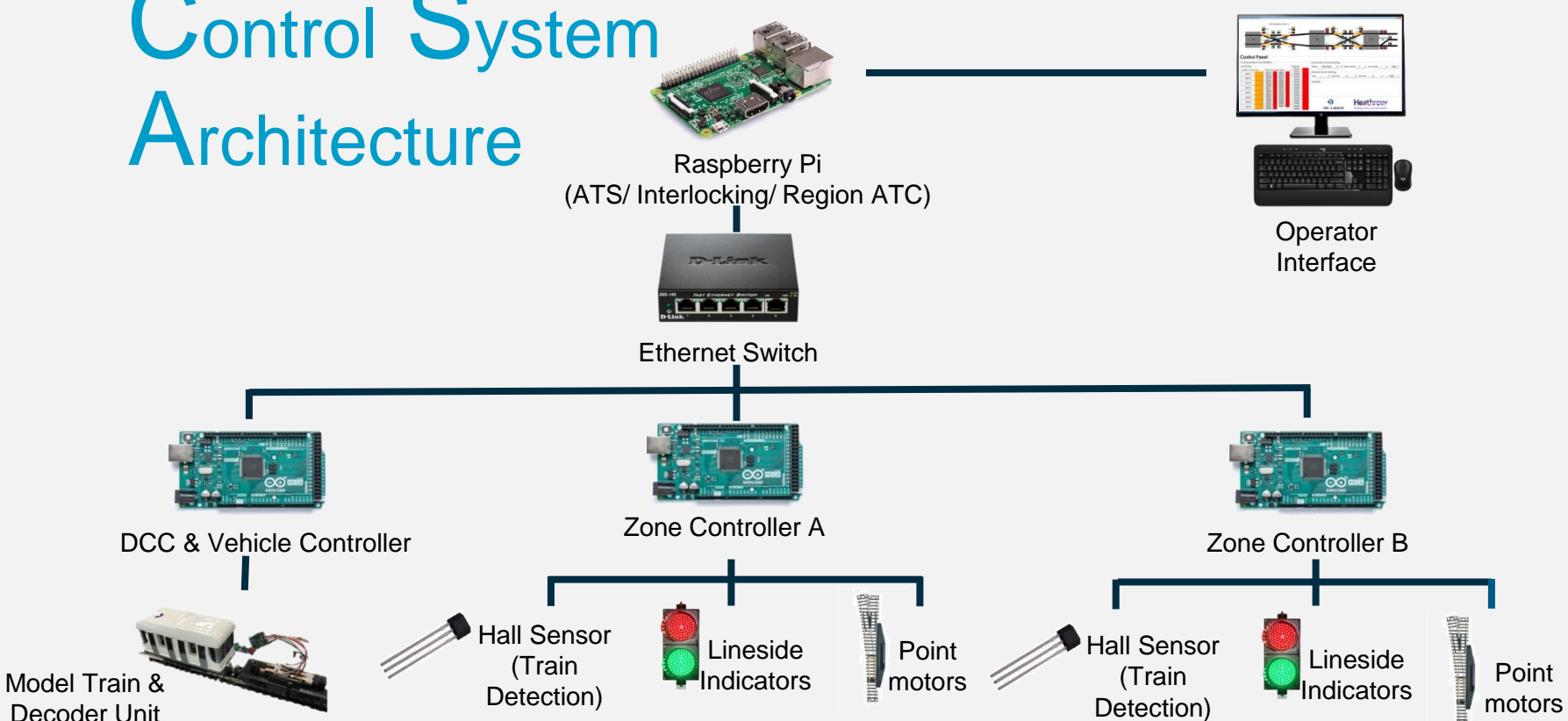

?!?! Snazzy ?!?!



Does it actually work ?



Train Ready to Depart



Did it really have an impact ?



- > 97 Likes
- > 2,691 Views
- > 11 Retweets

 **Heathrow T5 transit**
@T5Transit [Follow](#)

Coming to a toy shop near you soon 😊



0:15 2,692 views

1:19 PM - 30 Nov 2018

11 Retweets 97 Likes

13 11 97

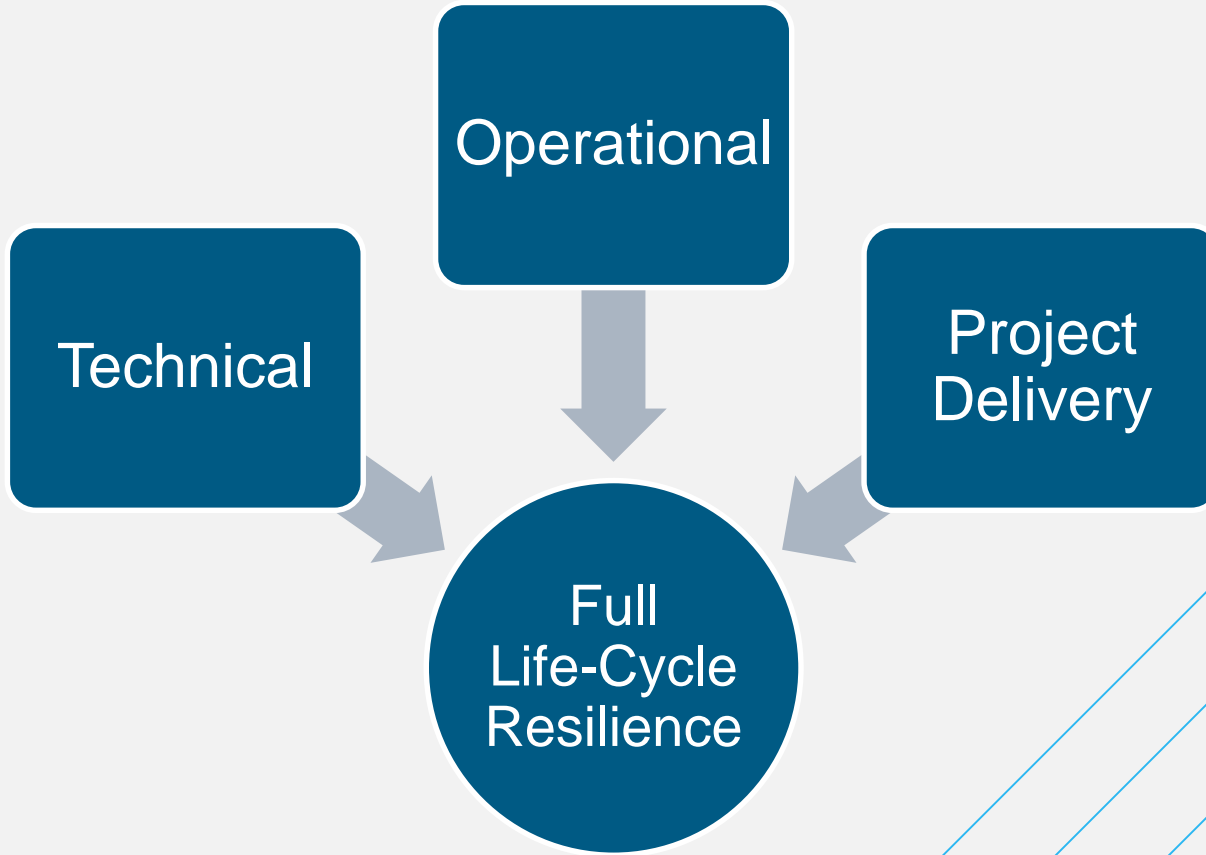

What did I learn ?



- Control system architecture
- How to create operational resilience
- How to build an interlocking
- Principles of signalling
- How to lock routes
- When to unlock routes
- How to manage a programme
- How to manage budget
- How to manage colleagues
- How to manage client expectation
- Importance of version control
- Importance of written documentation
- How to build a communication network
- How to account for poor train detection
- Difference route and approach locking
- Importance of operational resilience
- How to ensure operational readiness
- Importance of stakeholder engagement
- Power of a model
- How to present complex themes
- Operation of an interlocking
- Operation of a Vehicle Control Centre
- Operation of Zone Controllers
- How to build a Vehicle Control Centre
- How to build a Zone Controller
- How to code in Python
- How to communicate over Ethernet
- What is a pinched loop
- How to determine route prioritisation

Importance of building competency through

Hands-on and Tangible Experience

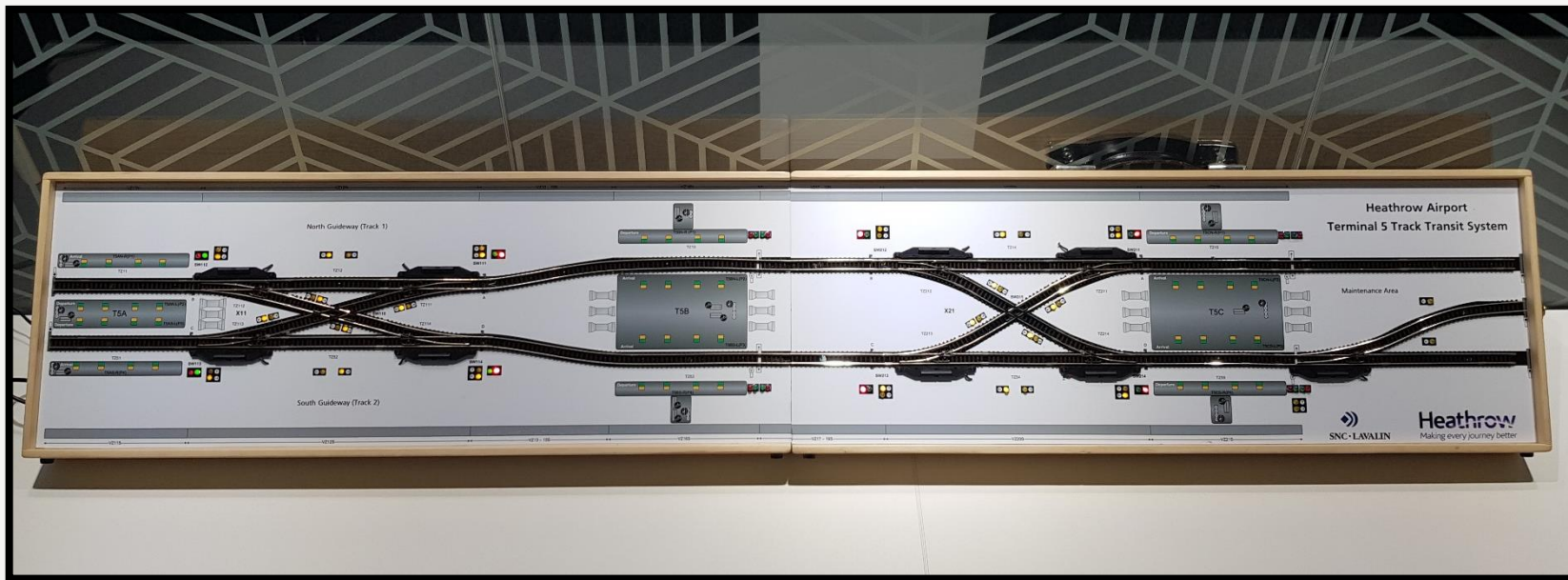

Thank You For Listening

What Building a Model Taught Me About the Real Railway

Aaron Sawyer

